

For detailed video installation instructions, please go to: [www.unex.com/resources/video-library](http://www.unex.com/resources/video-library)

A Flow Cell modular unit starts with a framework of vertical Posts & horizontal Beams (**Flow Cell Structure**) bolted together with 3/8"-16 hardware (included)—only one wrench size (9/16") is required. This base structure plus **Span-Track carton flow track** and any of several optional features complete the Flow Cell assembly.

## FLOW CELL STRUCTURE

**1** Attach side Beams (2) to Posts (2) for each side of cell — one high, one low. FlowCell with Tool Bar will have 2 longer posts at front. Note: Ensure foot plates oriented in the same direction. If using rigid casters, align long dimension of plates in direction cell is to roll. The 3/8"- 16 UNC GRADE 2 hardware used to assemble the Flow Cell has a recommend torque of 20 lb-ft.

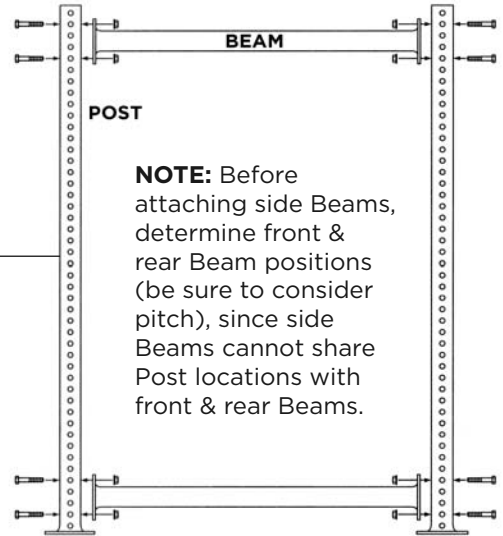

**2** Join the 2 sides by bolting on front beams at discharge heights at front of cell. For return lane front beam would be at load height.



**3** Bolt on rear beams for each level approximately 1" higher per foot than front beams. Recommended pitch is 1 inch for every 1 foot of rack depth.



**4** Slip plastic End Caps onto posts.

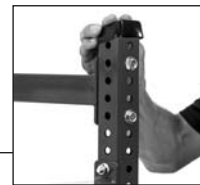

## FLOW CELL OPTIONS (all necessary brackets and hardware are included)

### CASTERS

Attach casters to foot plates using 3/8" bolts. (provided)



### WORKBENCH

Attach shelf brackets (2) to posts at desired height using 3/8 bolts. Attach workbench, inserting 4 bolts from below.

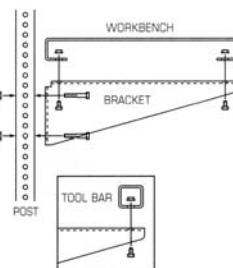

### OVERHEAD TOOL BAR

Attach brackets (2) at top of front posts using 3/8" bolts. Attach tool bar strut channel with 2 bolts inserted from below, and 2 strut nuts.

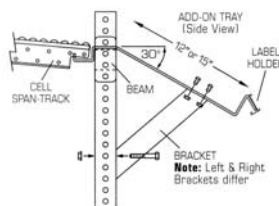

### ADD-ON TRAY

Attach tray brackets to tray. Hang back of tray over front beam. Bolt brackets to posts. Attach full-length Label Holder to front surface of Add-On Tray using two-sided tape (provided on back side of Label Holder).

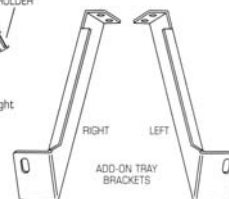

For detailed video installation instructions, please go to: [www.unex.com/resources/video-library](http://www.unex.com/resources/video-library)

FlowCell™ framework (vertical Posts & horizontal Beams) accepts Cell Span-Track and High Profile Span-Track models.

**CELL SPAN-TRACK (LANE OR BED)**

Drop-in installation. Notched front end rests on beam. Flat plate at rear wraps over beam.

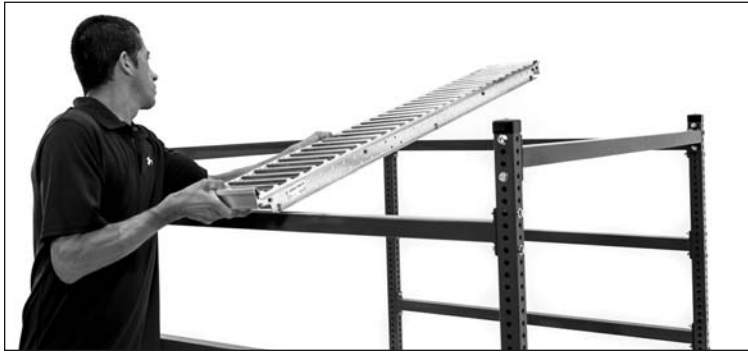

**HIGH PROFILE & KNUCKLE SPAN-TRACK LANE**

Attach pre-punched Retainer Angles to front and rear beams (fig. 1) using supplied tek screws. Position track on retainers and lock into desired position with Lock Arm at load end of track (fig. 2).

Lock Arm can be positioned for track end flush with beam or overhanging.



Figure 1

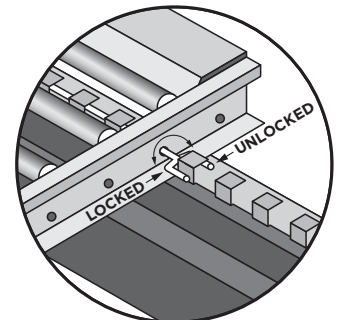

Figure 2



Knuckled end of track must extend entirely beyond beam

**HIGH PROFILE SPAN-TRACK WHEEL**

Position the wheel bed track in the desired location on top of the beams. Once you have the position selected, line up bracket with channel hole and beam hole. Now affix the bracket with included hardware to the track. Once hardware is installed you can tek screw the bracket to the beam on each side of the track. Repeat for each side of the channel. For more detailed installation instructions and video please refer to the product page at: [unex.com/product/flow-cell](http://unex.com/product/flow-cell)

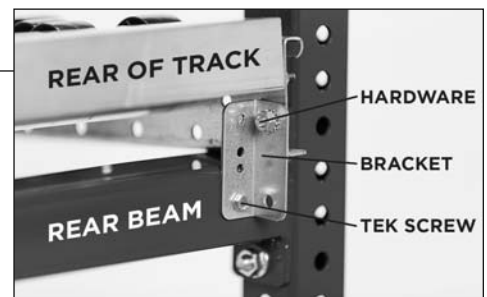

**TEST PITCH**

With Span-Track installed test pitch to ensure that products/totes flow effectively. Adjust beams if necessary.



Pick Smarter. Pick Better. Pick UNEX.

UNEX MANUFACTURING, INC.

691 New Hampshire Avenue, Lakewood, NJ 08701  
800.695.SPAN (7726)

732-928-2800 • fax: 732-928-2828 • e-mail: [span@unex.com](mailto:span@unex.com) • [unex.com](http://unex.com)

[www.unex.com/resources/video-library](http://www.unex.com/resources/video-library)

INS-FLOW-000